









150 AETJ-C

		150 AETJ-C
	Working height	15 m
	Platform height	13 m
	Articulation height	7 m
	Outreach	7.60 m
	Jib tilting	+70° / -70°
	Jib Movement (option 3D)	+70° / -70°
	Basket rotation	140°
	Turret rotation	355°
	Capacity	200 kg
	Number of persons (indoor/outdoor)	2/2
	Basket (width and length)	1.20 x 0.96 m
	1. Overall width	1.50 m
	2. Overall length	6.05 m
	3. Overall height	1.97 m
	4. Overall length when folded	4.40 m
	5. Overall height when folded	2.08 m
	6. Interior turning circle	1.87 m
	7. Exterior turning circle	3.96 m
	8. Exterior turning circle	4.82 m
	9. Ground clearance	14 cm
	10. Wheelbase	2.00 m
	Speed of forward movement	5 kph
	Working speed	0.60 kph
	Maximum slope accessible	25 %
	Maximum tilt	5 % / 3°
	Tyres	0.60 x 0.19 m
	Driving wheels	2 (back)
	Steering/directional wheels	2 (front)
	Weight	6700 kg
	(varies according to options & standards of the country)	
	Batteries	240 Ah / 2 x 24 V
	Integrated charger	45 Ah / 48 V

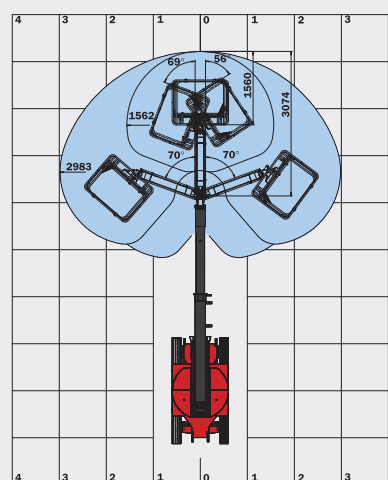
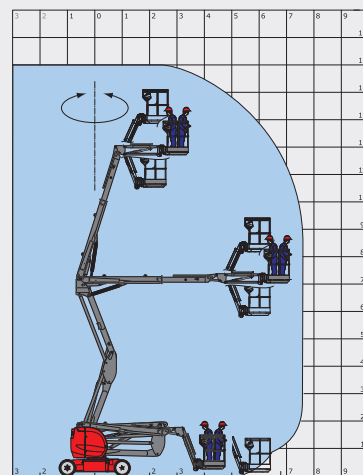

Option 3D: Jib Movement

Standard equipment

- Proportional switches/levers
- Forward movement possible at maximum height
- Sound and visual alarm in case of excessive slant and overload
- Integrated charger
- Emergency manual descent
- Negative braking system
- Sound warning system inside the platform
- Hour meter
- Indication of state of charge of batteries
- Hooks for sling loading/lifting
- Integrated diagnostic aid
- Predisposition 220V
- Tyres with non-marking edges
- Basket with transparent floor
- Bus CAN technology
- Tool box inside platform

Optional equipment

- Flashing lights
- Working light
- Predisposition of air
- Predisposition of water
- 230V power input with differential circuit-breaker
- Special paint
- Biodegradable oil
- Rotation of pendulum arm (3D)
- High capacity battery (360 Ah)
- Central topping up of batteries
- Warning signal moving forward
- Warning signal for all movements
- Protective cover for instruments panel
- Initial certificate of verification prior to entry into service
- Safety harness

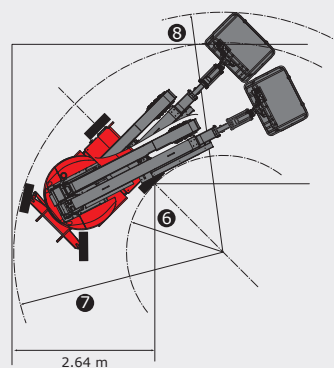
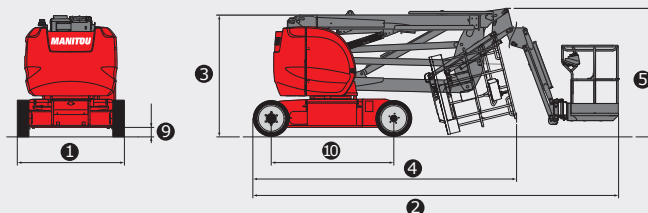

This brochure describes versions and configuration options for Manitou products which may be fitted with different equipment. The equipment described in this brochure may be standard, optional or not available depending on version. Manitou reserves the right to change the specifications shown and described at any time and without prior warning. The manufacturer is not liable for the specifications given. For more information, contact your Manitou dealer. Non-contractual document. Product descriptions may differ from actual products. List of specifications is not comprehensive. The logos and visual identity of the company are the property of Manitou and may not be used without authorisation. All rights reserved. The photos and diagrams contained in this brochure are provided for information only.

MANITOU BF SA - Limited company with board of directors - Share capital: 39,547,824 euros - 857 802 508 RCS Nantes

